

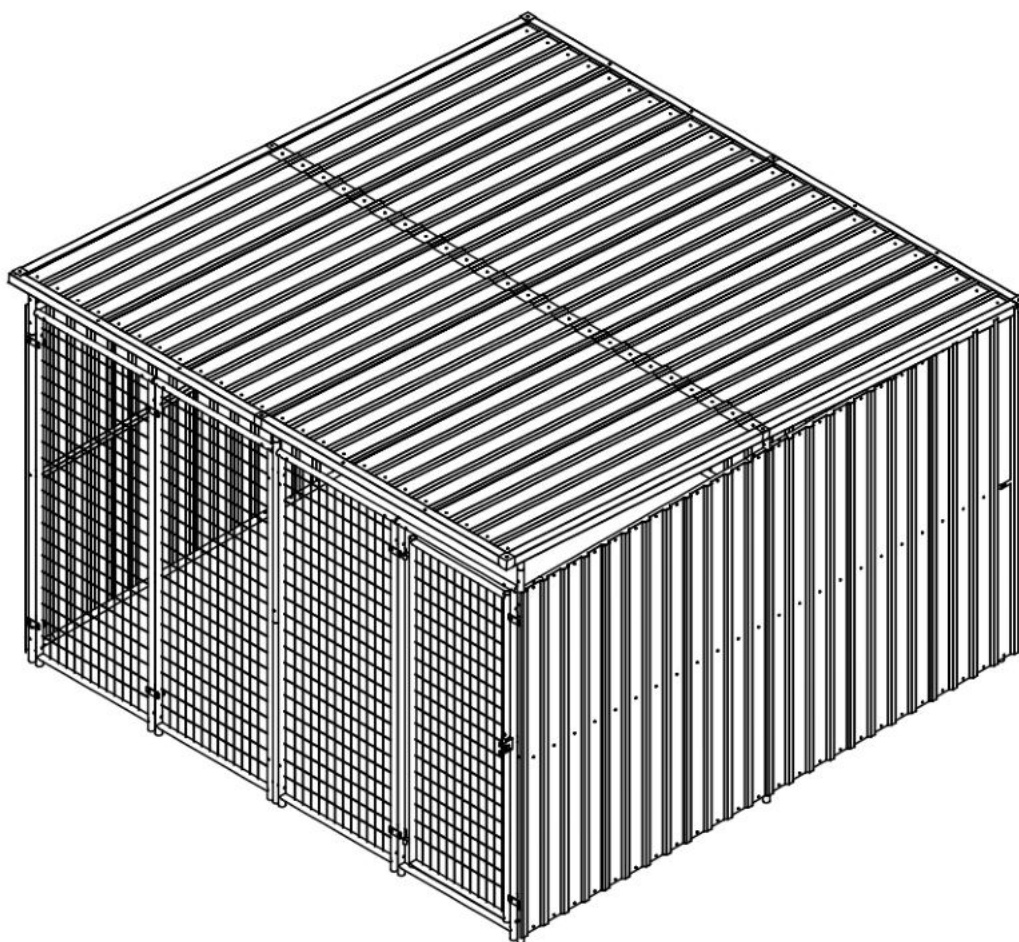













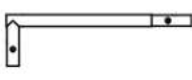





# DOGNY TYP 7

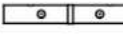



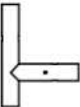
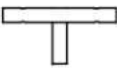
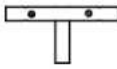
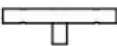
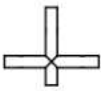
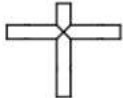







ATENȚIONARE: UNELE PIESE AU MUCHII ASCUȚII.  
CÂND MANIPULAȚI PIESE INDIVIDUALE, ESTE NECESAR SĂ PROCEDEȚI  
CU ATENȚIE PENTRU A EVITA UN ACCIDENT. DIN MOTIVE DE SIGURANȚĂ,  
VĂ RUGĂM SĂ CITIȚI INFORMAȚIILE DE SIGURANȚĂ DIN ACEST MANUAL  
ÎNAINTE DE A ÎNCEPE MONTAREA. PURTAȚI MĂNUȘI LA MANIPULAREA  
CU PIESELE METALICE.

<b>BP1</b>		<b>18</b>	<b>Q7</b>		<b>2</b>
<b>BP11</b>		<b>6</b>	<b>Q8</b>		<b>1</b>
<b>BP12</b>		<b>6</b>	<b>Q8A</b>		<b>1</b>
<b>Q1</b>		<b>4</b>	<b>Q9</b>		<b>1</b>
<b>Q2</b>		<b>2</b>	<b>Q10</b>		<b>2</b>
<b>Q3</b>		<b>4</b>	<b>Q11</b>		<b>1</b>
<b>Q4</b>		<b>2</b>	<b>Q12</b>		<b>1</b>
<b>Q5</b>		<b>1</b>	<b>Q13</b>		<b>2</b>
<b>Q6</b>		<b>2</b>	<b>QD1</b>		<b>3</b>

<b>QD2</b>		<b>1</b>
<b>QD3</b>		<b>1</b>
<b>T1</b>		<b>2</b>
<b>T2</b>		<b>2</b>
<b>T3</b>		<b>1</b>
<b>T4</b>		<b>1</b>
<b>TT1</b>		<b>2</b>
<b>TT2</b>		<b>2</b>
<b>ZU1</b>		<b>2</b>

<b>ZU2</b>		<b>1</b>
<b>ZU3</b>		<b>1</b>
<b>ZU4</b>		<b>1</b>
<b>ZU5</b>		<b>1</b>
<b>ZA1</b>		<b>4</b>
<b>ZA2</b>		<b>4</b>

<b>G1</b>		<b>2</b>
<b>G2</b>		<b>1</b>
<b>M7</b>		<b>4</b>
<b>L7</b>		<b>1</b>
<b>K37</b>		<b>16</b>



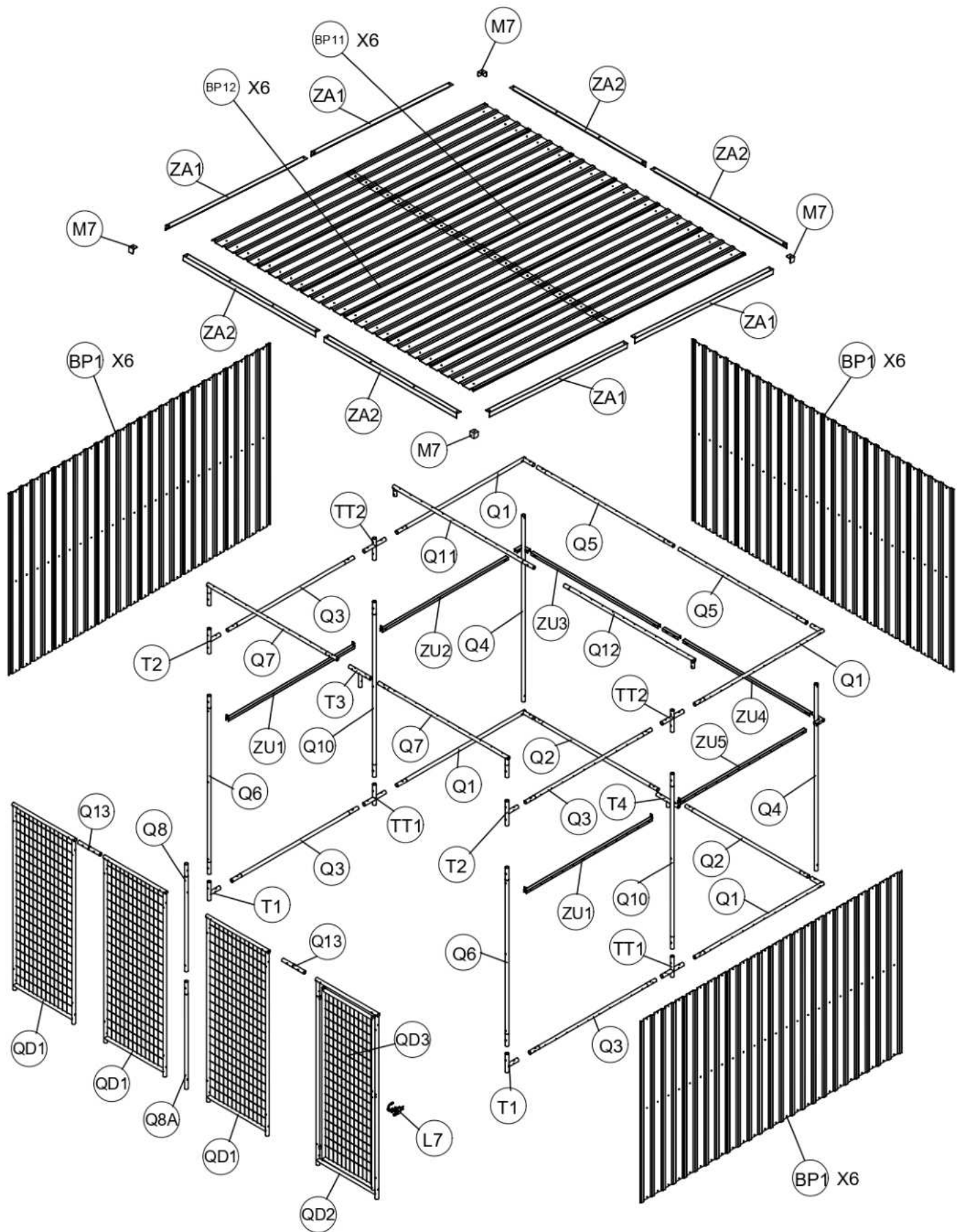

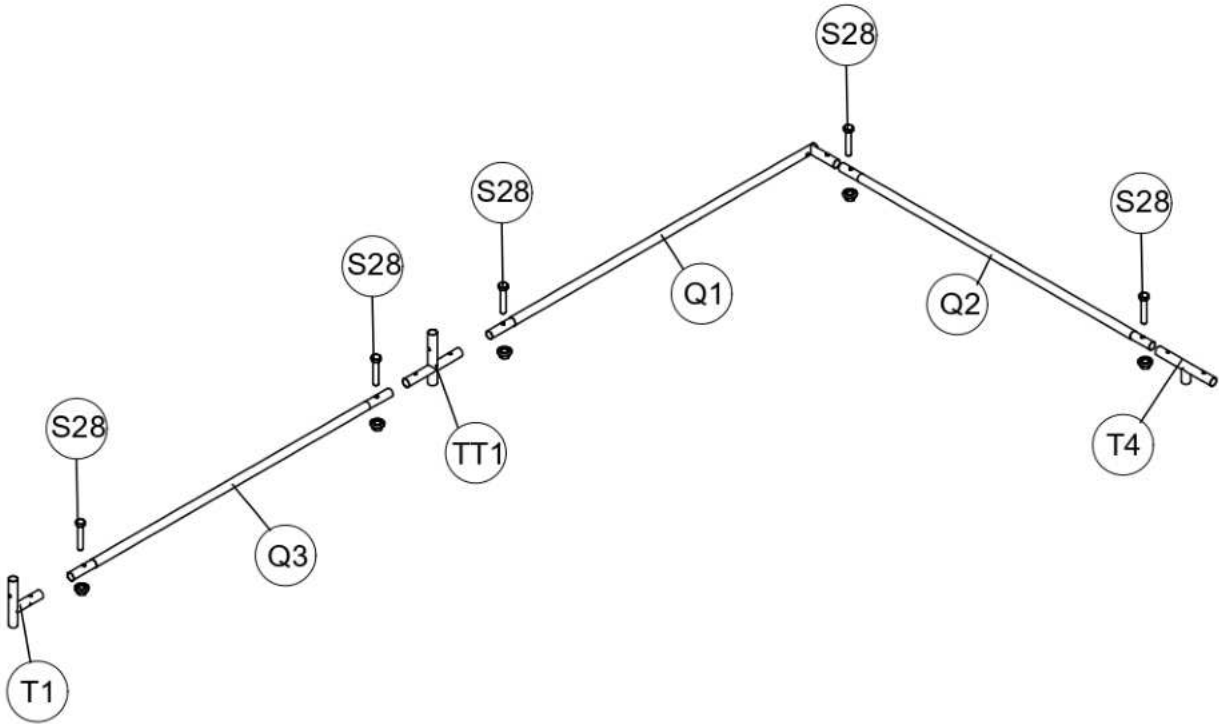
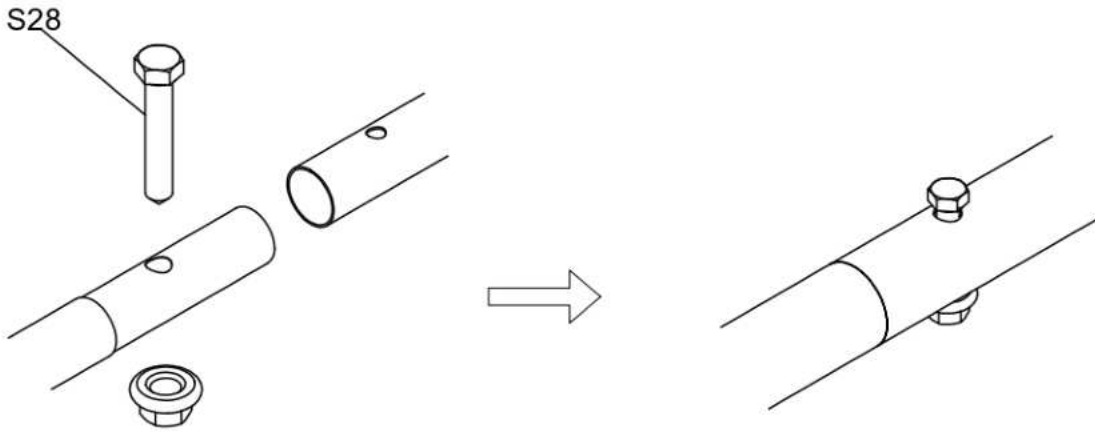
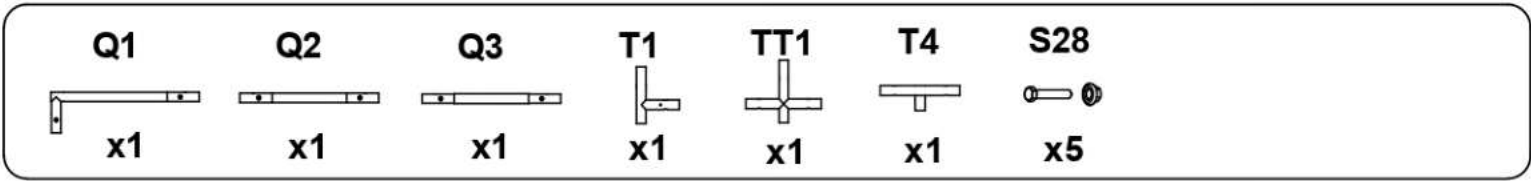

<b>S26</b>		<b>304</b>
<b>S28</b>		<b>61</b>
<b>S29</b>		<b>4</b>
<b>S30</b>		<b>2</b>
<b>S31</b>		<b>4</b>



1.





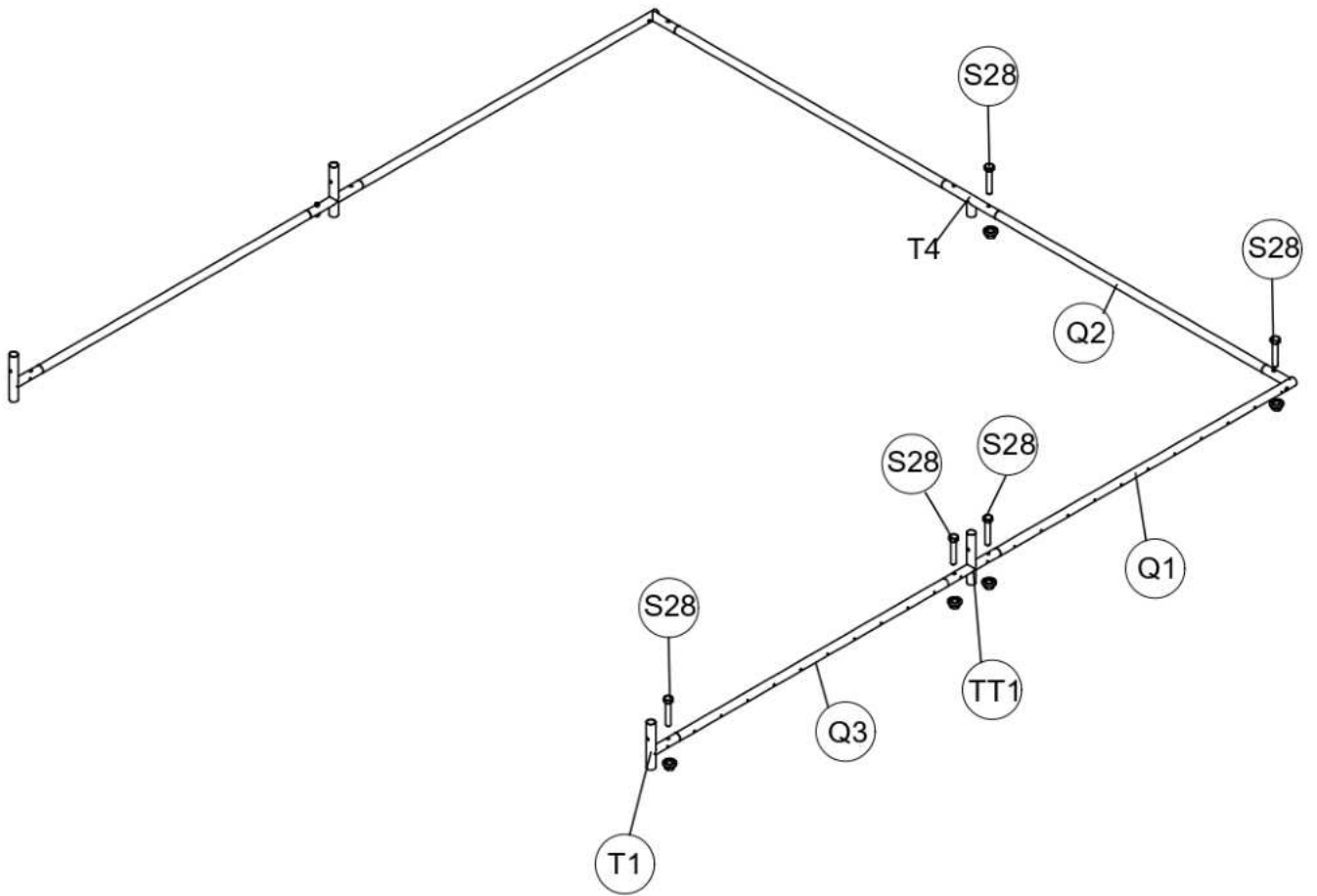
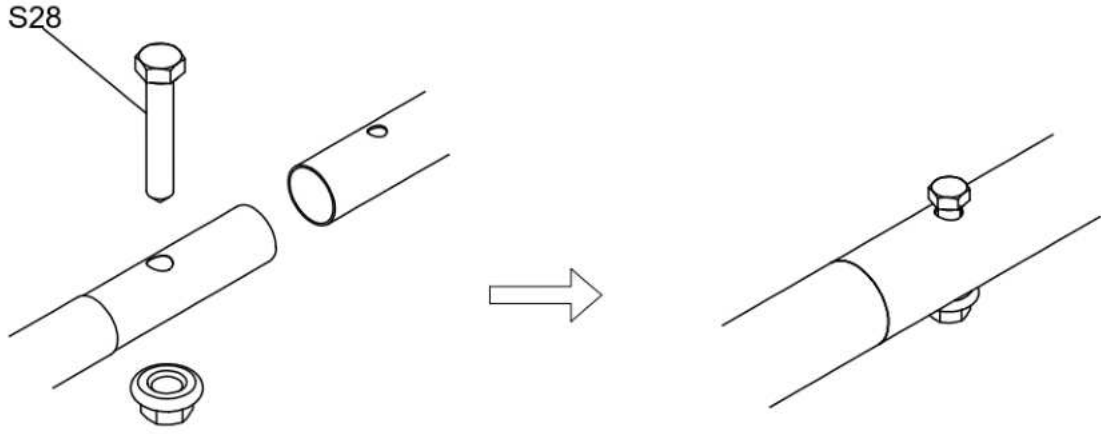

# 2.

<b>Q1</b>  x1	<b>Q2</b>  x1	<b>Q3</b>  x1	<b>T1</b>  x1	<b>TT1</b>  x1	<b>S28</b>  x5
---	--	--	--	---	--







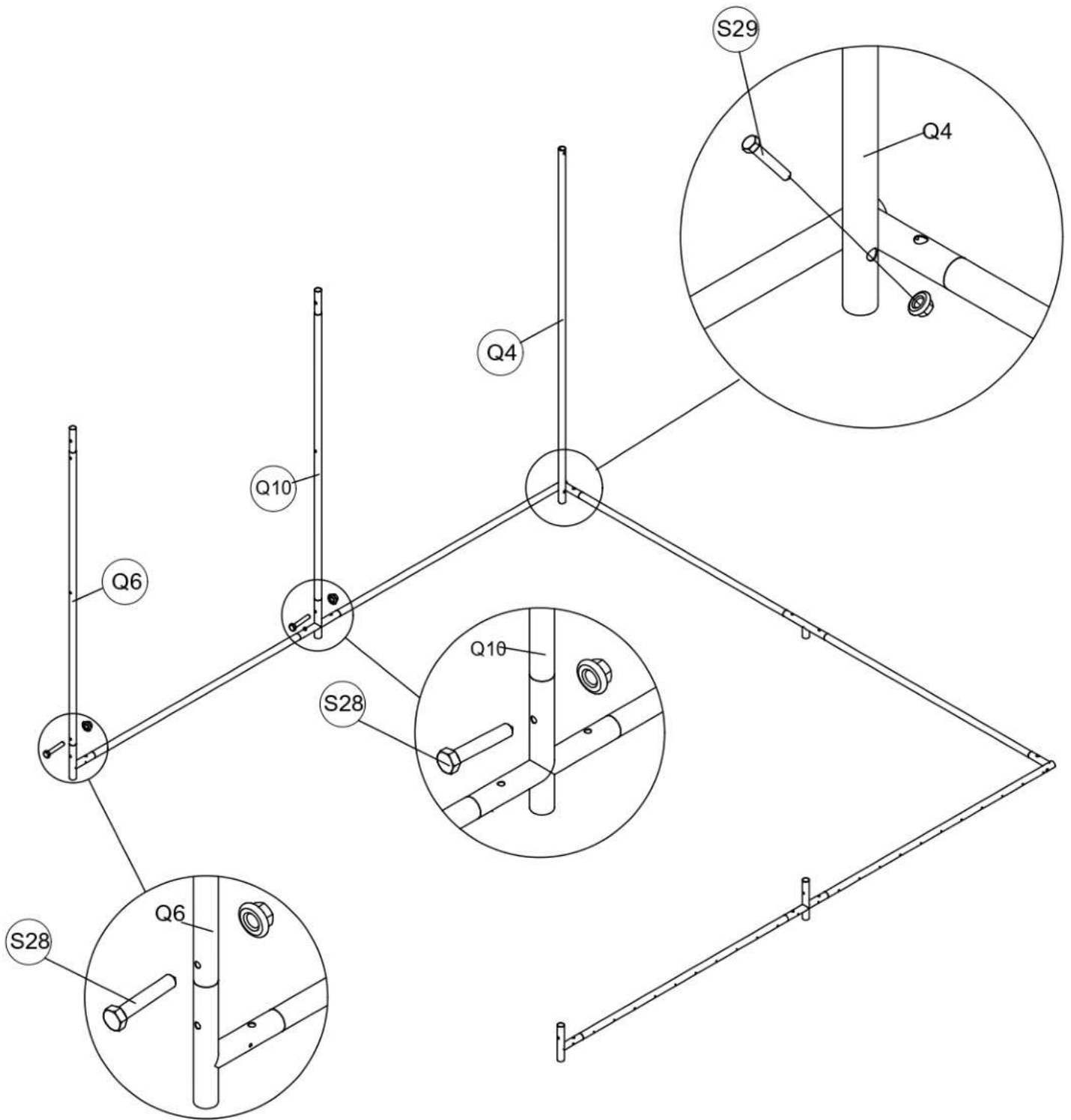



# 3.

<b>Q4</b>  x1	<b>Q6</b>  x1	<b>Q10</b>  x1	<b>S28</b>  x3	<b>S29</b>  x1
---	--	---	---	---









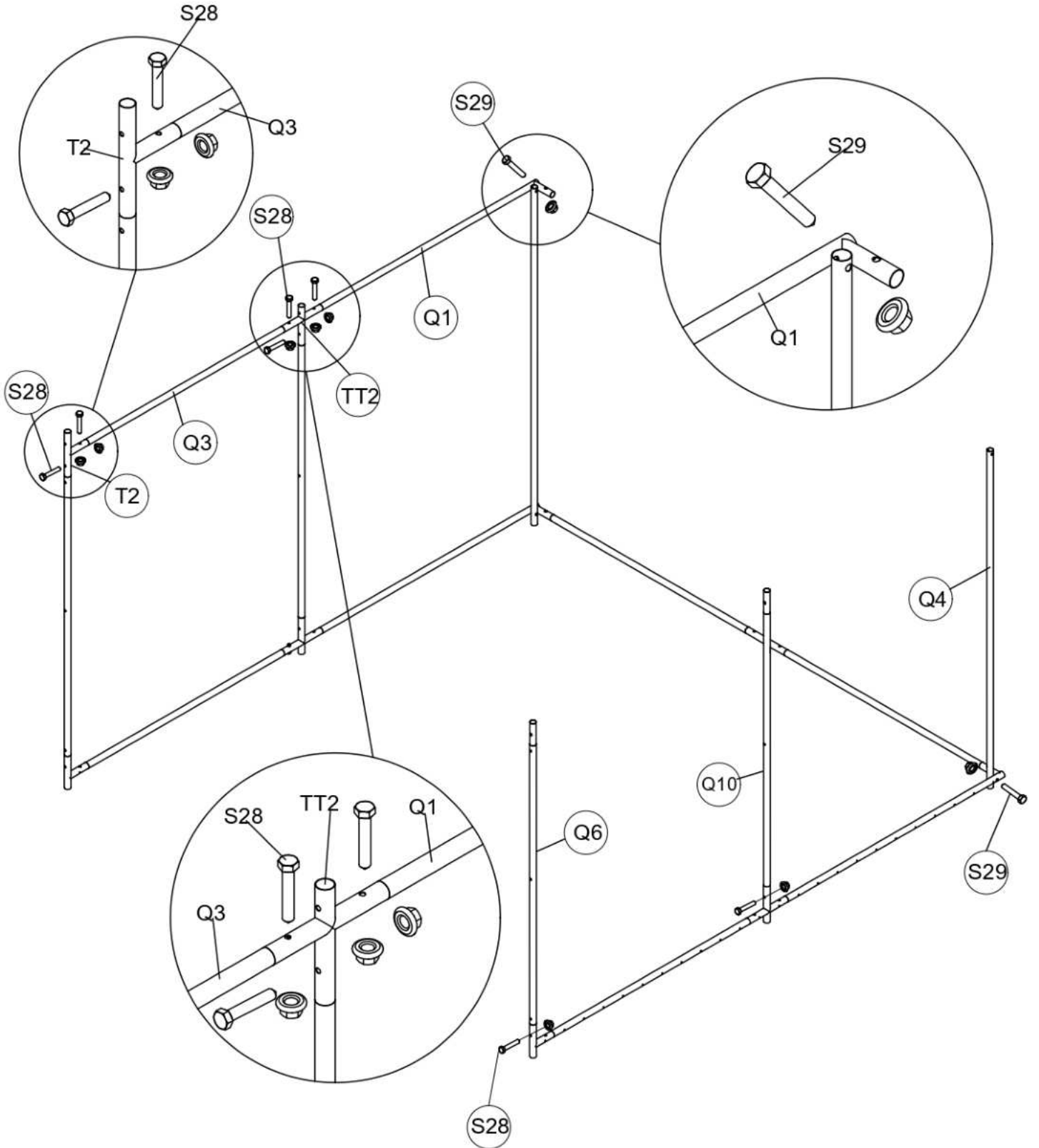

# 4.

<b>Q1</b>	<b>Q3</b>	<b>Q4</b>	<b>Q6</b>	<b>Q10</b>	<b>T2</b>	<b>TT2</b>	<b>S28</b>	<b>S29</b>
								
x1	x1	x1	x1	x1	x1	x1	x7	x2



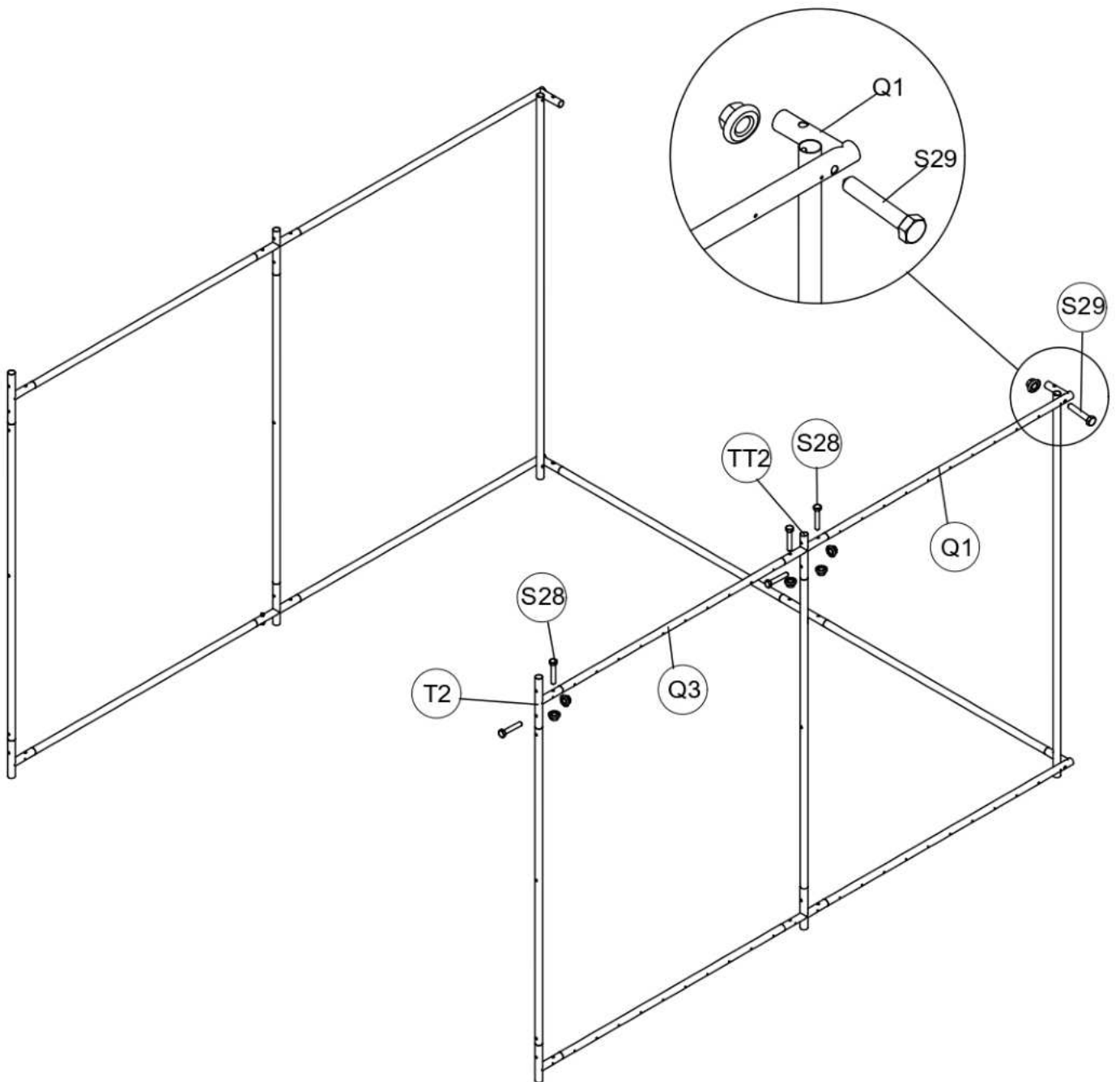

# 5.

<b>Q1</b>  x1	<b>Q3</b>  x1	<b>T2</b>  x1	<b>TT2</b>  x1	<b>S28</b>  x5	<b>S29</b>  x1
---	--	--	---	---	---



6.



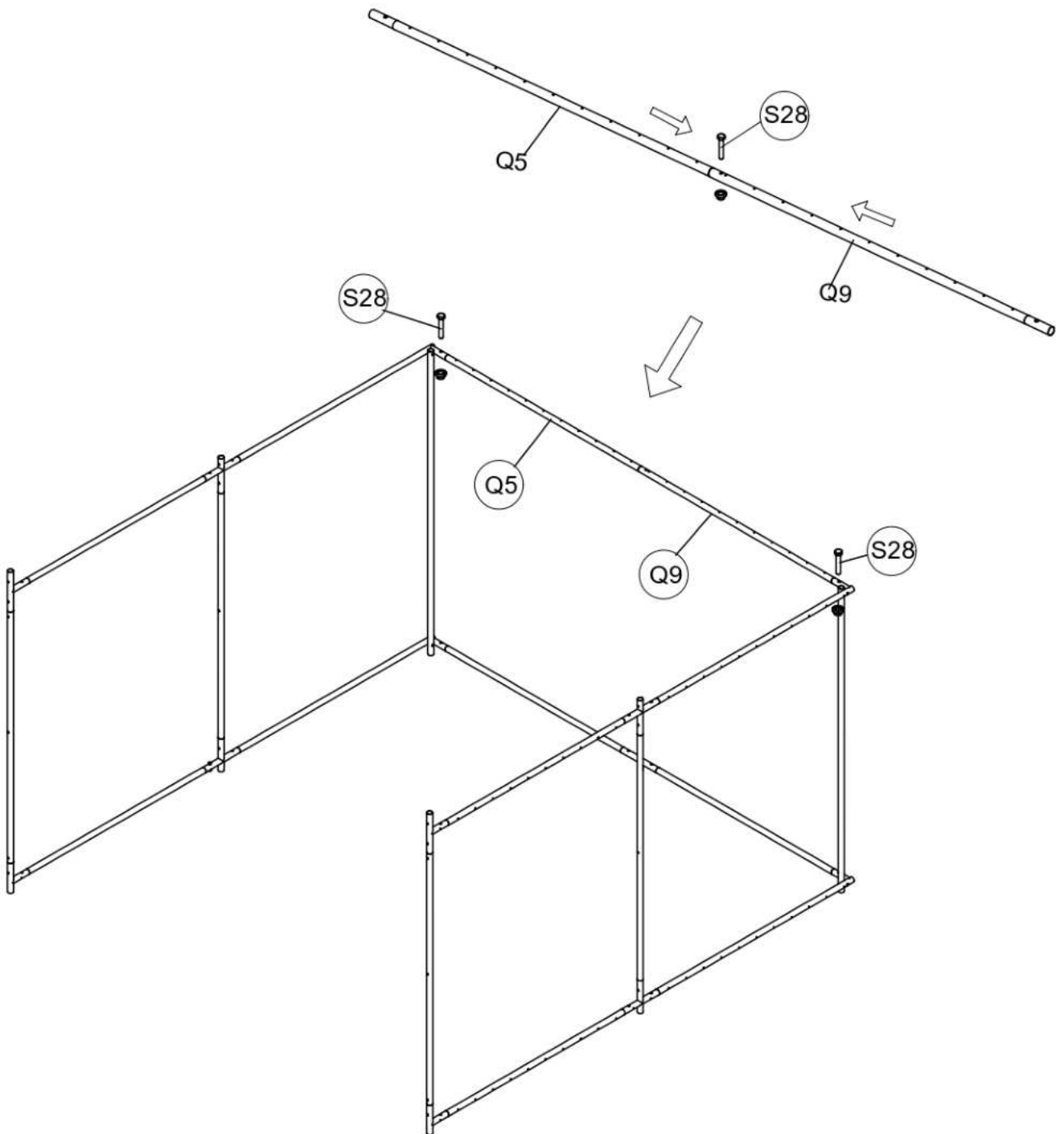

<b>Q5</b>  x1	<b>Q9</b>  x1	<b>S28</b>  x3
--	--	---

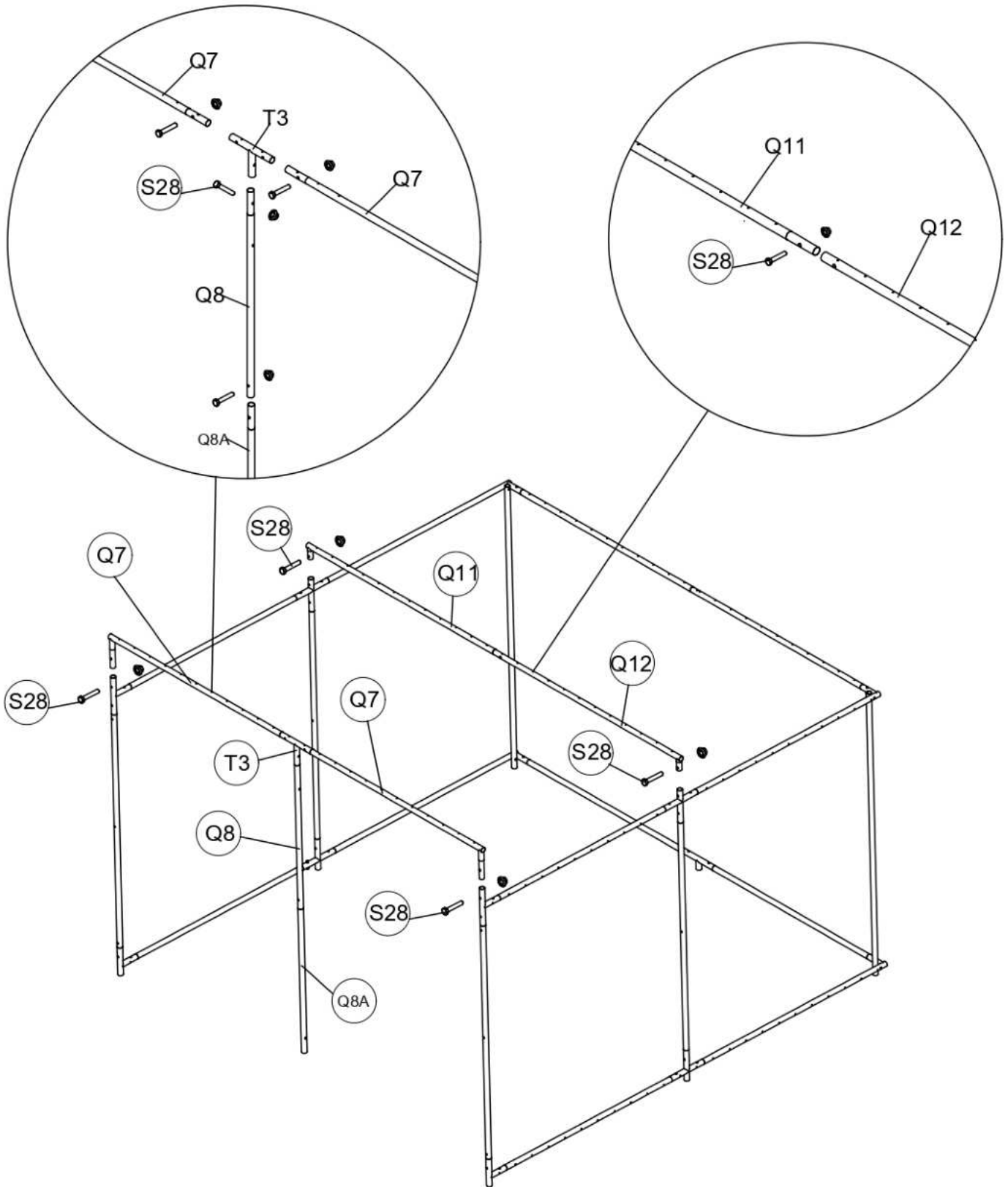
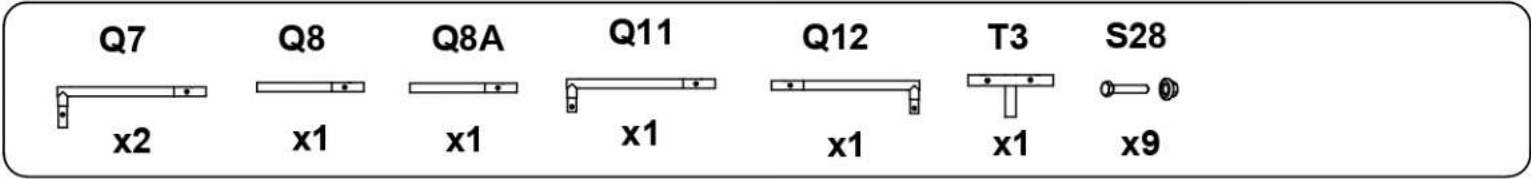

# 7.



# 8.

<b>QD1</b>  x3	<b>QD2</b>  x1	<b>Q13</b>  x2	<b>K37</b>  x8	<b>S28</b>  x12
--	---	---	---	--

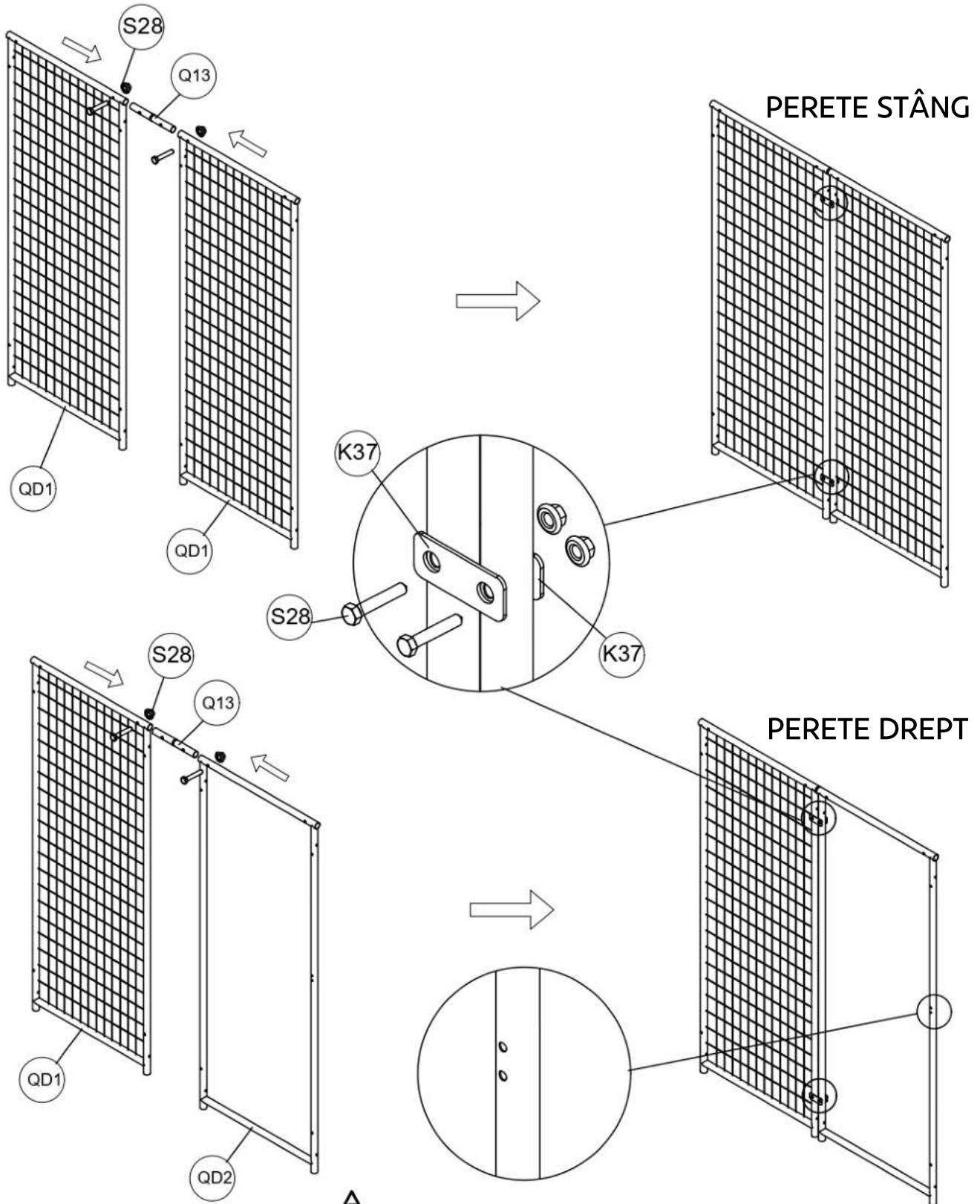

Dirijarea atenției

9.

**K37**    **S28**    **S30**



x8



x8



x2

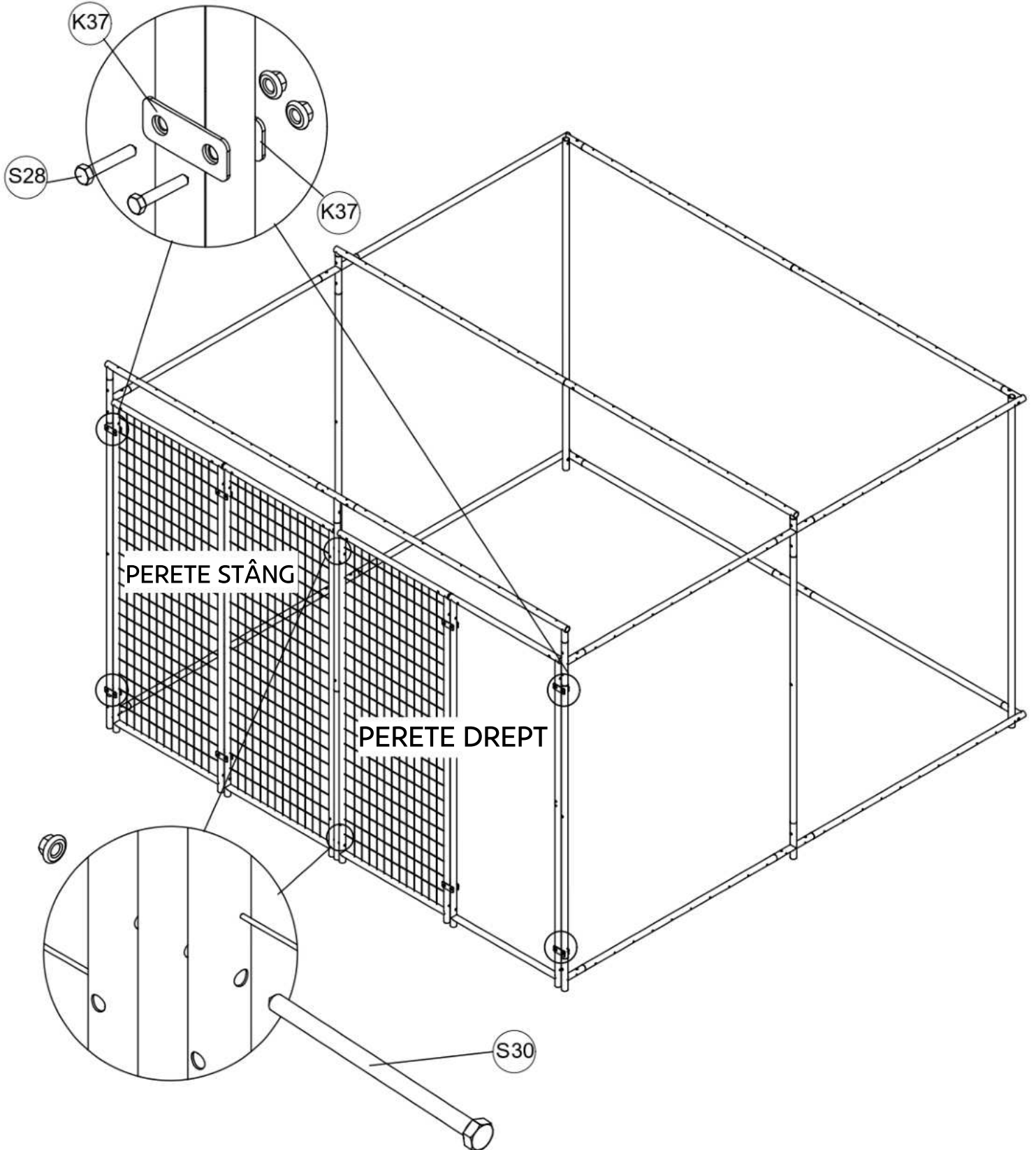

# 10.

**QD3**  
  
x1

**L7**  
  
x1

**S31**  
  
x4

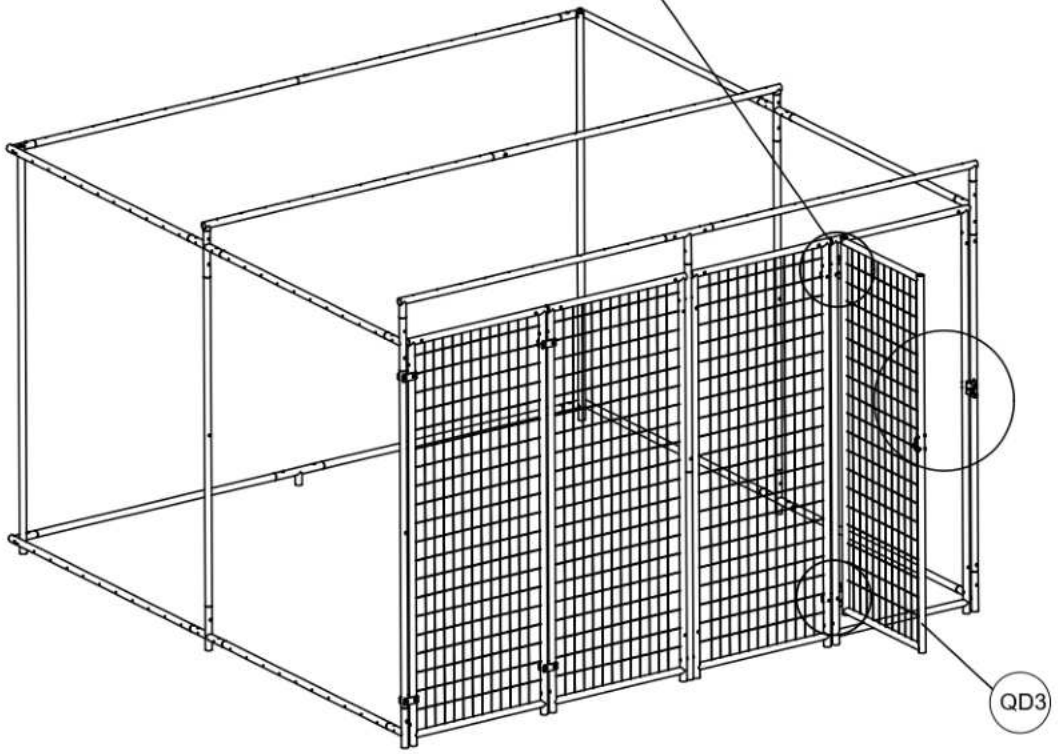
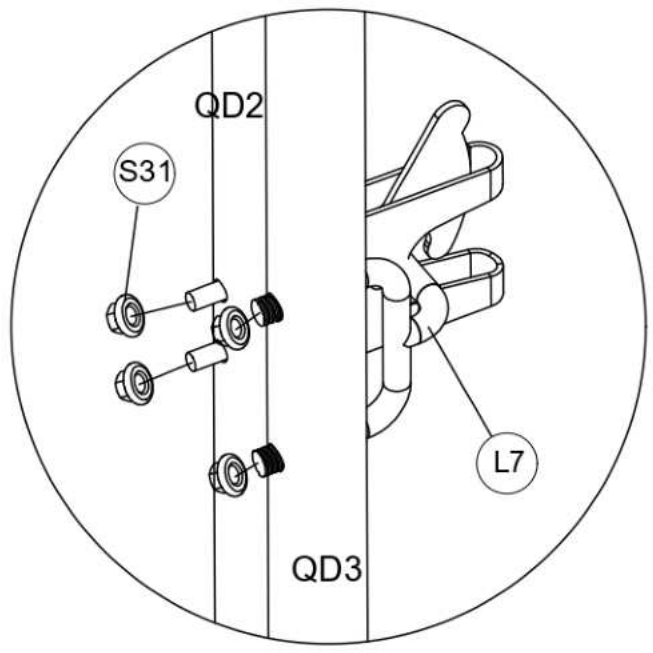
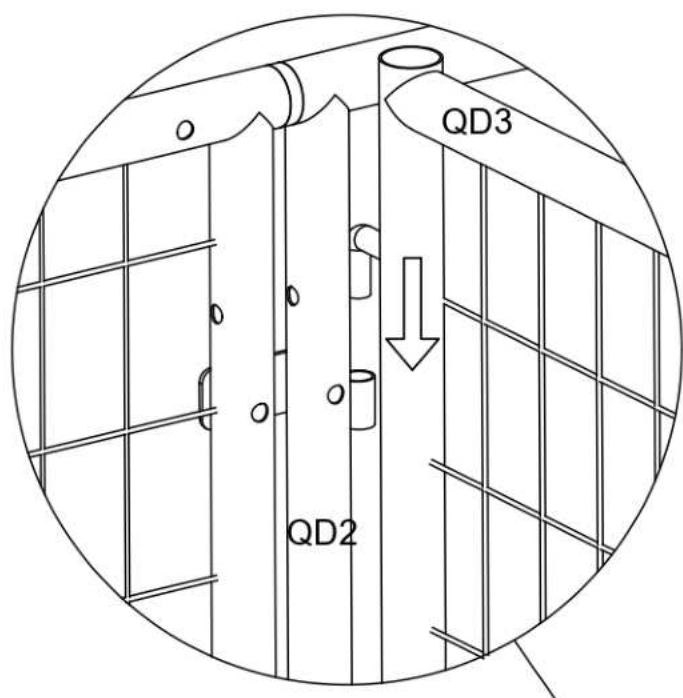

# 11.

BP1

S26



x6

x48

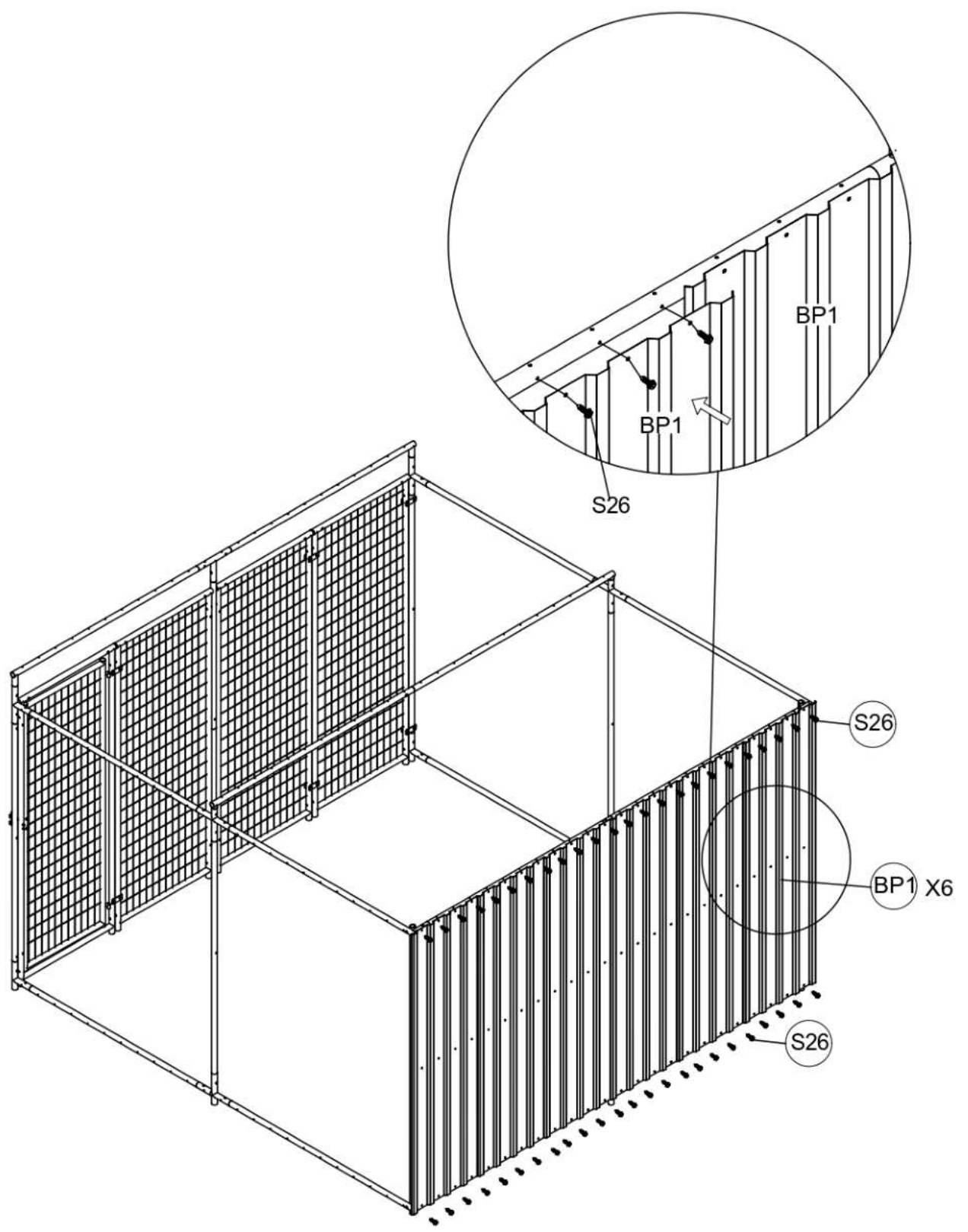



# 12.

ZU3

ZU4

G2

S26



x1



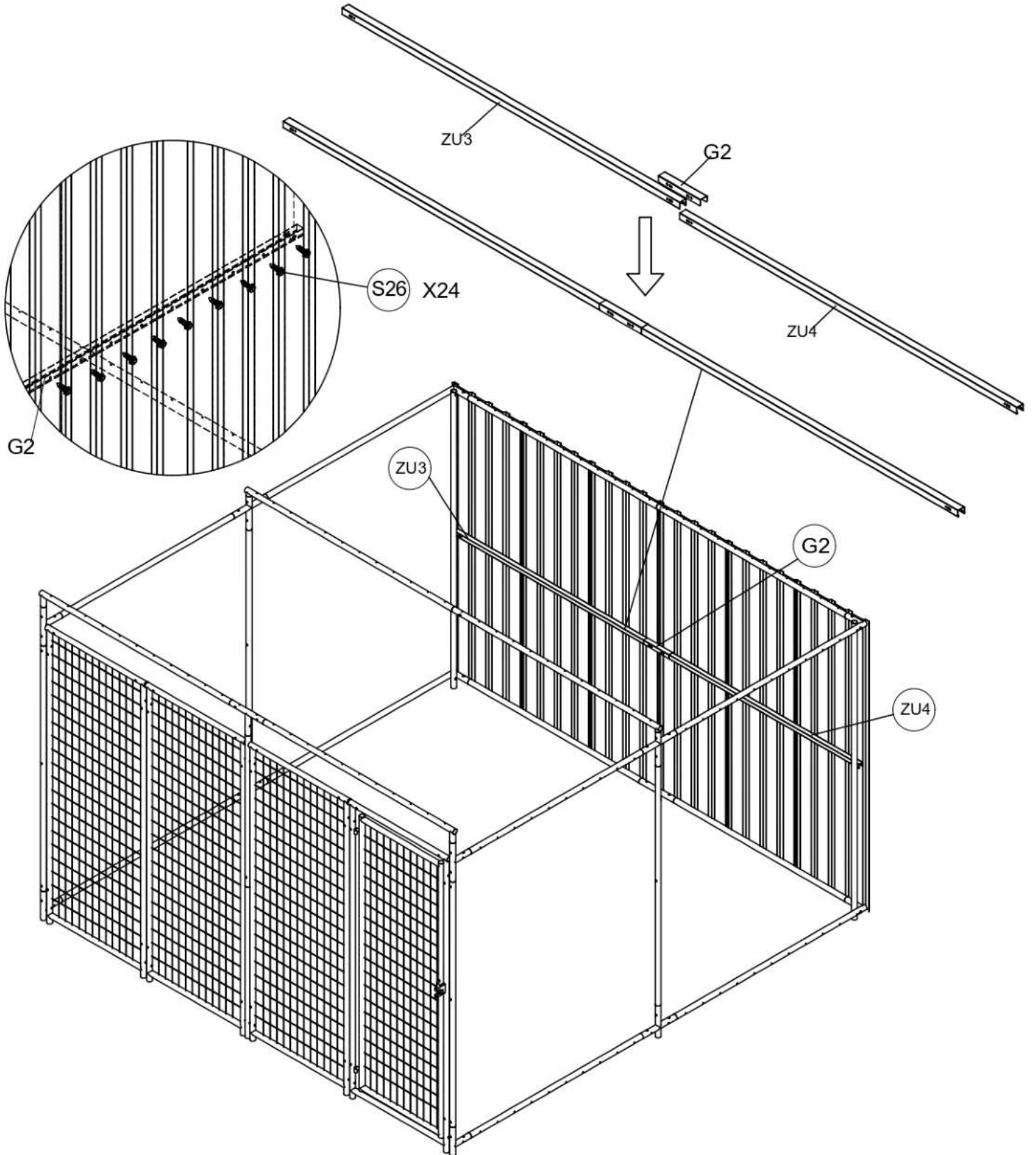

x1

x1

x24



# 13.

ZU1	ZU2	ZU5	G1	S28
				
x2	x1	x1	x2	x4

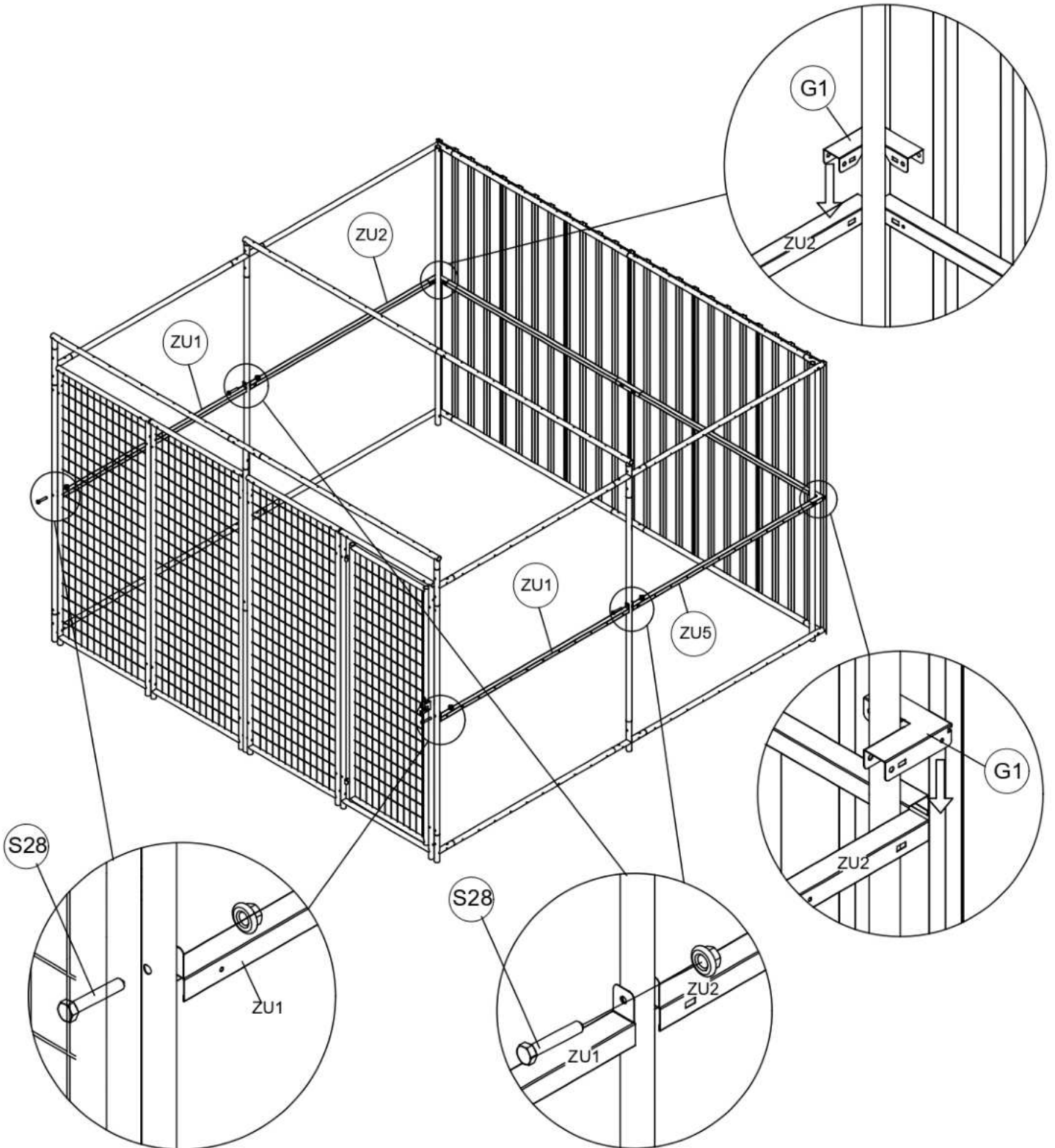

# 14.

BP1

S26



x12

x144

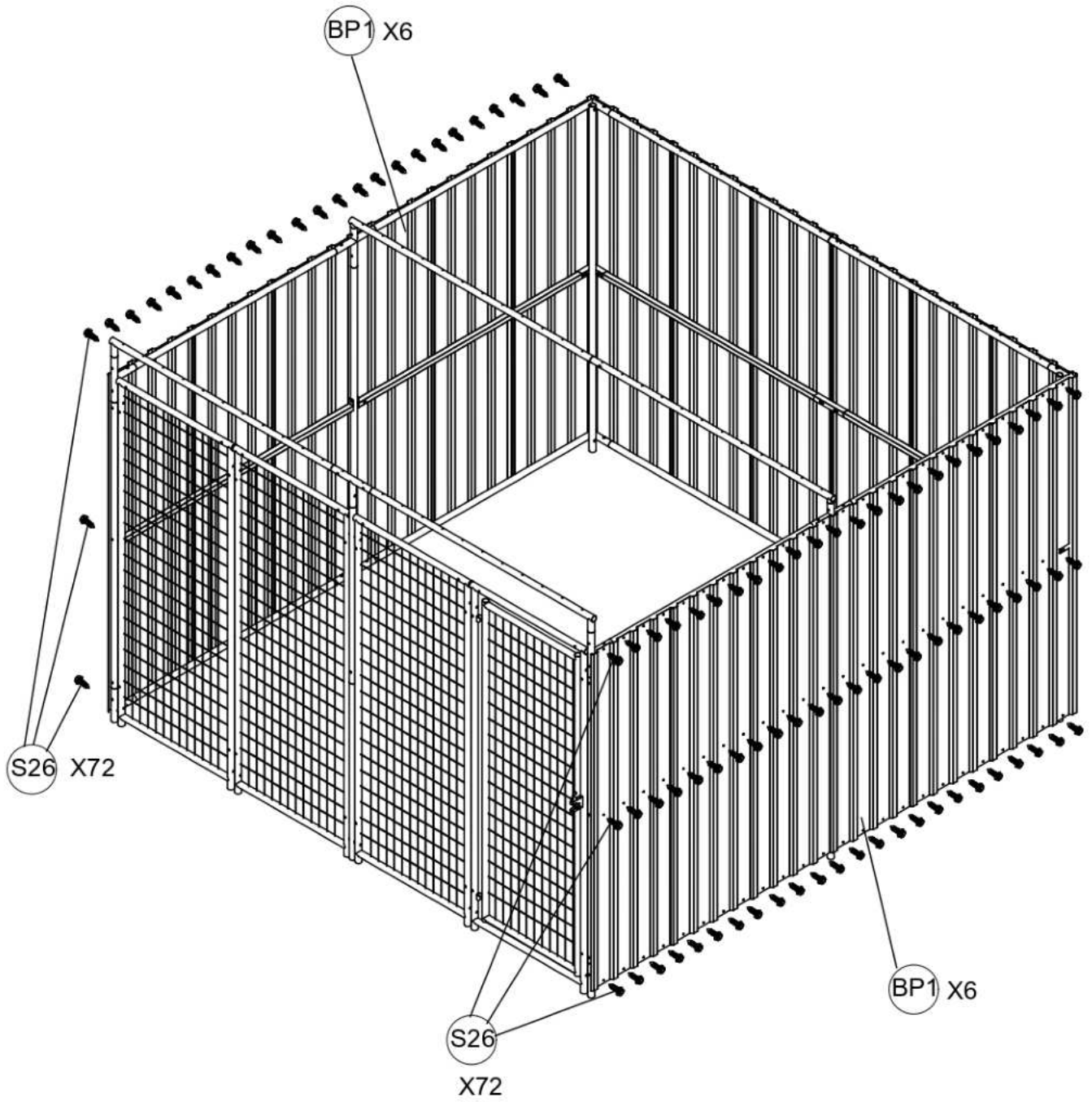

# 15.

BP11

S26



x6

x24

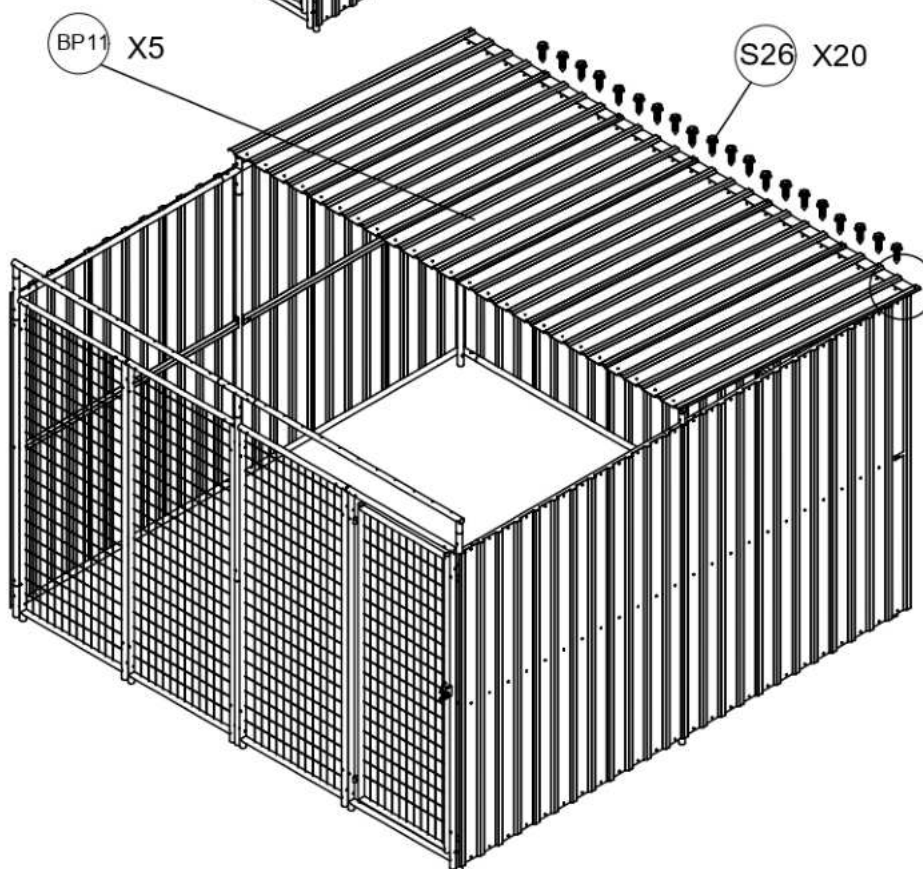
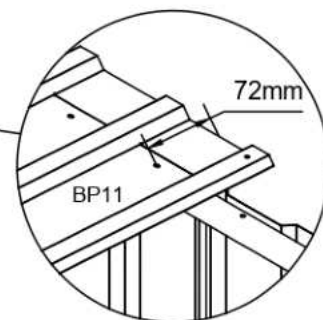
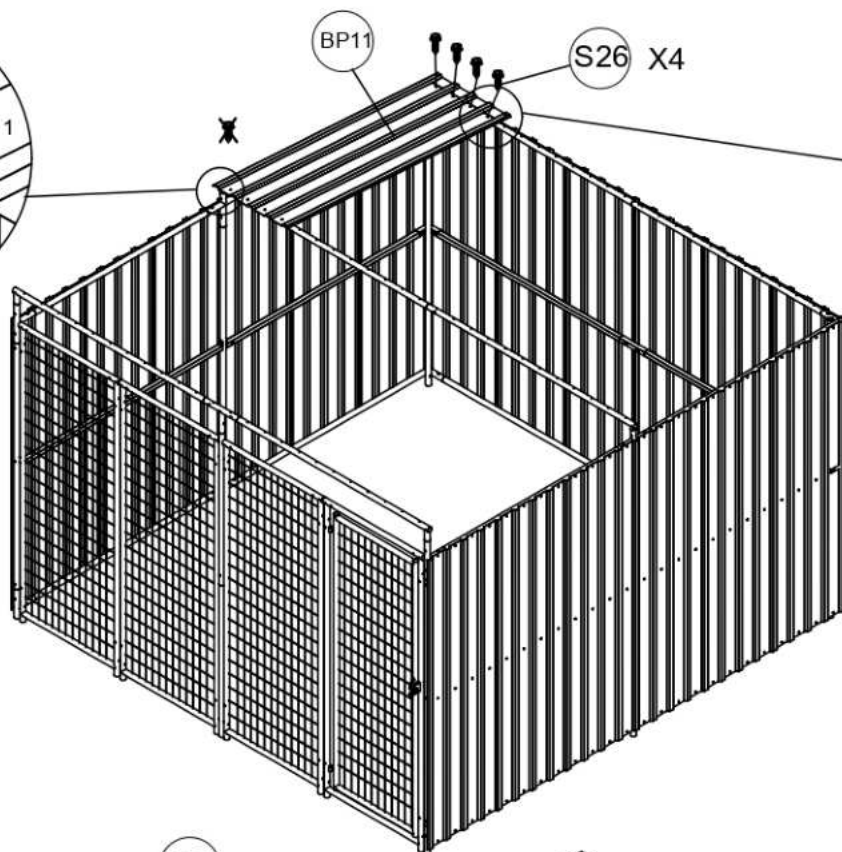
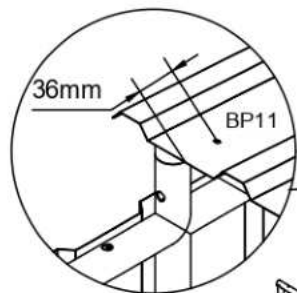

# 16.

BP12

S26



x6

x48

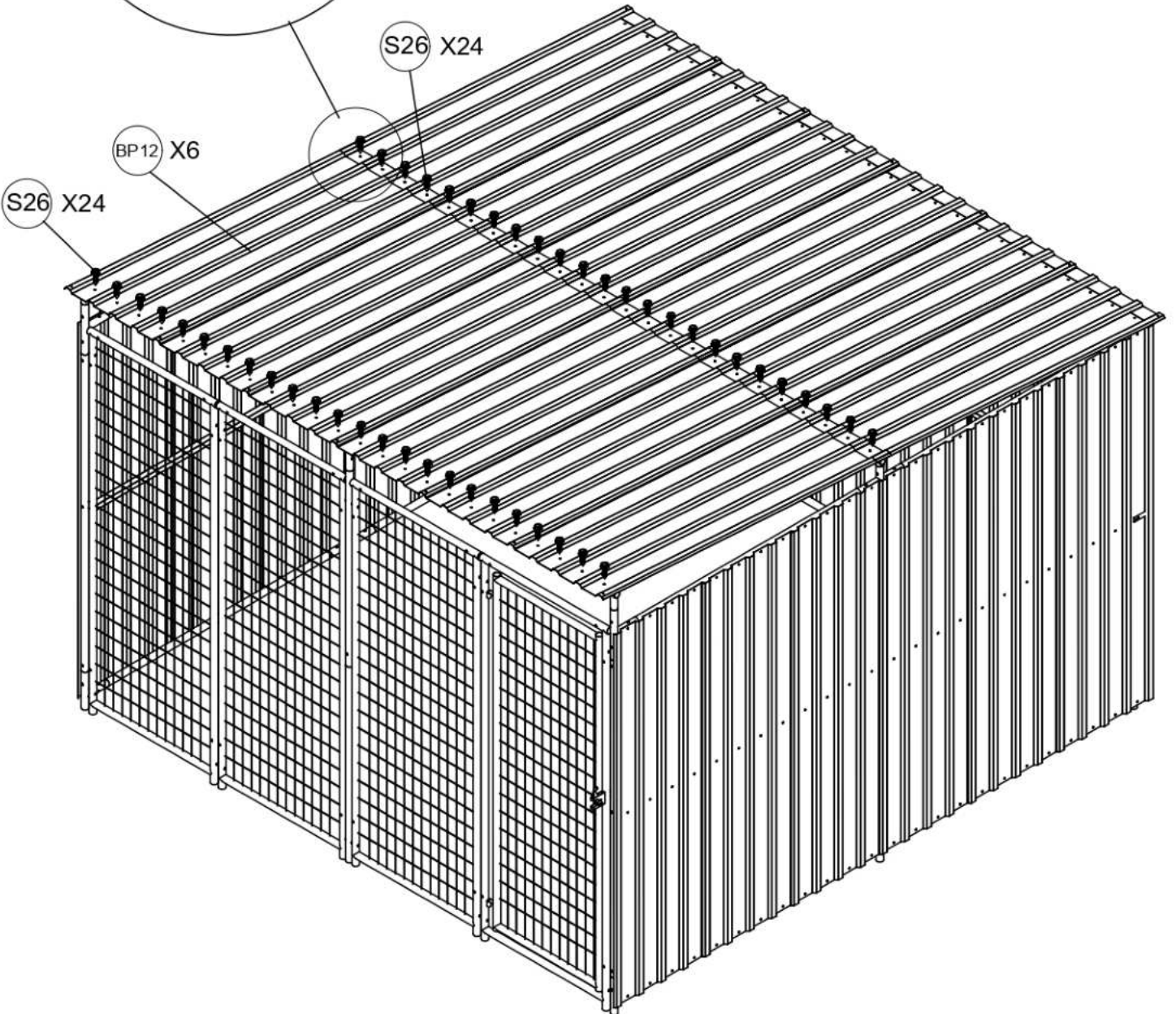
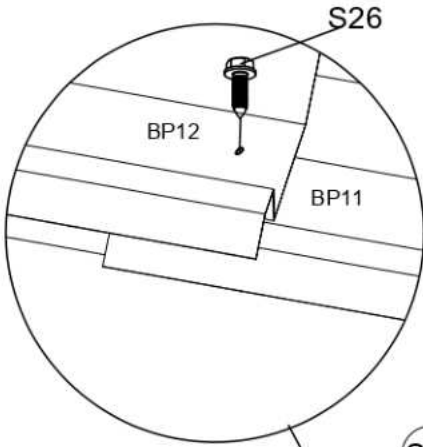

17.

ZA1  
x4

ZA2  
x4

M7  
x4

S26  
x16

